

# Owner's Manual ONE PUMP (5H2) & TWO PUMP (5H3)

---



PN 378201 Rev E  
Euro

# OWNER'S INFORMATION

## DEALER

Company \_\_\_\_\_  
Address \_\_\_\_\_  
Phone \_\_\_\_\_  
E-mail \_\_\_\_\_

## INSTALLER

Company \_\_\_\_\_  
Address \_\_\_\_\_  
Phone \_\_\_\_\_

## SPA

Model (see below) \_\_\_\_\_  
Serial Number (see below) \_\_\_\_\_  
Color \_\_\_\_\_  
Date of Delivery \_\_\_\_\_

For the model and serial numbers, locate the white plate to the right or left of the access door, near the floor.

<b>CE</b>	<b>Roto Ops LLC</b> Lake Mary, FL	<b>Volts:</b>
		<b>Amps:</b>
		<b>CirBrk:</b>
<b>Model No:</b>		<b>Hz:</b>
<b>Options:</b>		<b>SN:</b>
<b>Mfg Date:</b>		
<b>FOR INDOOR/OUTDOOR USE</b>		<b>Assembled In the USA</b>

## TABLE OF CONTENTS

IMPORTANT SAFETY INSTRUCTIONS.....	4-8
SELECTING A LOCATION.....	9-10
SPA COVER INSTALLATION.....	11
FILLING YOUR SPA.....	12
DRAINING YOUR SPA.....	13
FOR THE ELECTRICIAN TWO PUMP (5H3).....	14-15
SYSTEM OPERATION TWO PUMP (5H3).....	16-17
FOR THE ELECTRICIAN ONE PUMP (5H2).....	18-19
SYSTEM OPERATION ONE PUMP.....	20-21
DISPLAY MESSAGES.....	22
SKIMMER-FILTER, CLEANING OR REPLACEMENT OF THE FILTER CARTRIDGE.....	23
AIR INJECTOR VENTURI ADJUSTMENT.....	24
ADJUSTABLE WATER FLOW JETS.....	24
WATERFALL FLOW ADJUSTMENT.....	24
WATER CHEMISTRY.....	25-26
REPLACING THE LED LIGHT.....	27
HEADREST INSTALLATION.....	28
FREEZE PROTECTION.....	29
CLEANING YOUR SPA.....	29
CARE FOR THE COVER .....	29
FREQUENTLY ASKED QUESTIONS.....	30
PURGING THE PUMP.....	31
TROUBLESHOOTING GUIDE.....	32
GLOSSARY OF TERMS.....	33
OZONE (OPTIONAL EQUIPMENT).....	34

# Important Safety Instructions for all Spa Owners

## READ AND FOLLOW ALL INSTRUCTIONS CAREFULLY!

This spa was manufactured to meet the standards and specifications outlined in the “Virginia Graeme Baker Pool and Spa Safety Act” (VGB Safety Act). When installing and using this spa, basic safety precautions should always be followed, including:



### 1. **DANGER: RISK OF INJURY: (For cord and plug connected units):**

- Replace damaged cord immediately
- Do not bury cord
- Connect to a grounded, grounding type receptacle only.

### 2. **WARNING: (For permanently installed units):** All installations must be protected by a Residual Current Device (RCD) having a rated residual operating current not exceeding 30 mA and a means for disconnection must be incorporated in the fixed wiring in accordance with all wiring rules.

### 3. **DANGER: RISK OF SEVERE INJURY OR DROWNING!**

- Extreme caution must be exercised to prevent unauthorized access by children.
- To avoid accidents, ensure that children do not use this spa unless supervised at all times. Adult supervision is a critical safety factor in preventing children from drowning.
- Use the straps and clip tie downs to secure the spa cover when not in use. This will help discourage unsupervised children from entering the spa. Keep the spa cover secure in high-wind conditions.
- There is no representation that the cover, clip tie-downs, or actual locks will prevent access to the spa.

### 4. **DANGER: RISK OF SEVERE INJURY OR DROWNING!**

- Keep hair, loose articles of clothing or hanging jewelry away from suction fittings, rotating jets or other moving components to avoid entrapment that could lead to drowning or severe injury.
- Never use the spa unless all suction guards, filter, filter lid, or skimmer assembly are installed to prevent body and/or hair entrapment.
- Never operate or use the spa if the filter, filter lid, or skimmer assembly are broken or any part of the skimmer assembly is missing. Please contact your dealer or nearest service center for service.
- The suction fittings and suction covers in this spa are sized to match the specific water flow created by the pump(s). If it is necessary to replace the suction fittings, suction covers or pump(s), be sure that the flow rates are compatible and are in compliance with the VGB Safety Act.
- Never replace a suction fitting or suction cover with one rated less than the flow rate marked on the original suction fitting. Using improper suction fittings or suction covers can create a body or hair suction entrapment hazard that may lead to drowning or severe injury.







### 5. **DANGER: RISK OF SEVERE INJURY FROM ELECTRIC SHOCK OR DEATH FROM ELECTROCUTION!**

- Install the spa at least 1.5m (5 feet), from all metal surfaces. As an alternative, a spa may be installed within 5 feet of metal surfaces if each metal surface is permanently connected (bonded) by a minimum 8.4 mm<sup>2</sup> (No. 8 AWG) solid copper conductor attached to the wire connector on the grounding bar, inside the equipment compartment on the equipment box.
- A grounding wire connector is provided on this unit to connect a minimum 8.4 mm<sup>2</sup> (No. 8 AWG) solid copper conductor between this unit and any metal equipment, metal enclosures of electrical equipment, metal water pipe, or conduit within 1.5m (5 feet) of the unit.
- Never permit any electrical appliance, such as a light, telephone, radio, television, etc. within 1.5m (5 feet) of a spa unless such appliances are built-in by the manufacturer.
- Never bring any electrical appliances into or near the spa.
- Never operate any electrical appliances from inside the spa or when you are wet.

### 6. **WARNING: RISK OF SEVERE INJURY OR DEATH!**

- Extreme caution must be exercised to prevent diving or jumping into that the spa or slipping and falling, which could result in unconsciousness, drowning, or serious injury. Remember wet surfaces can be very slippery.
- Never stand, walk or sit on the top railing of the spa.
- Always use care in and around your spa. The spa has many rigid, unyielding parts and many areas that become wet and slippery; these are all potentially dangerous when rough play is permitted or if care is not used, particularly when entering or leaving the spa.



7.  **WARNING: RISK OF HYPERTHERMIA (OVER-HEATING) CAUSING SEVERE INJURY, BURNS, WELTS OR DEATH!**
- Water temperature in excess of 40°C (104°F) may be injurious to your health.
  - Refer to Hyperthermia section on this manual for specific causes and symptoms of this condition.
  - The water in the spa should never exceed 40°C (104°F). Water temperatures between 38°C (100°F) and 40°C (104°F) are considered safe for a healthy adult.
  - Lower water temperatures are recommended for young children (children are especially sensitive to hot water) and when spa use may exceed 10 minutes.
  - The Consumer Products Safety Commission/USA has stated that the water temperature in a spa should not exceed 40°C (104°F).
  - Always test the spa water temperature before entering the spa. The user should measure the water temperature with an accurate thermometer since the tolerance of water temperature regulating devices may vary as much as +/- 2°C (5°F).
8.  **WARNING: RISK OF SEVERE INJURY OR DEATH!**
- Since excessive water temperatures have a high potential for causing fetal damage during the early months of pregnancy, if pregnant or possibly pregnant, consult your physician before using a spa.
  - Pregnant or possibly pregnant women should limit spa water temperatures to 38°C (100°F).
  - Persons suffering from obesity or a medical history of heart disease, low or high blood pressure, circulatory system problems, diabetes, infectious diseases or immune deficiency syndromes should consult a physician before using a spa.
  - If you experience breathing difficulties in association with using or operating your spa, discontinue use and consult your physician.
  - Persons using medication should consult a physician before using a spa since some medication may induce drowsiness, while other medication may affect heart rate, blood pressure, and circulation.
  - Persons suffering from any condition requiring medical treatment, the elderly, or infants should consult with a physician before using a spa.
  - If you have any questions about your own fitness or whether you should soak in the spa, check with your physician.
  - The use of alcohol, drugs, or medication before or during spa use may lead to unconsciousness with the possibility of drowning.
  - Never permit the spa to be used unless it is attended by at least one person other than the bather. Someone should be present to lend assistance if the bather should be in trouble due to injuries, cramps, or drowning, especially in case of children.
9.  **WARNING: RISK OF SEVERE INJURY OR DEATH!**
- Prolonged immersion in a spa may be injurious to your health.
  - Observe a reasonable time limit when using the spa. Exposures at higher temperatures can cause high body temperature (overheating). Symptoms may include dizziness, nausea, fainting, drowsiness, and reduced awareness. These effects could possibly result in drowning or serious injury.
  - Never use a spa immediately following strenuous exercise. Enter and exit the spa slowly. Wet surfaces can be slippery.
10.  **WARNING: TO DECREASE RISK OF INFECTION OR DISEASE!**
- To reduce the risk of contracting a waterborne illness (e.g. an infection, bacteria or virus) and/or respiratory ailments, maintain water chemistry within the parameters listed in the Water Chemistry section of this manual and consult with a licensed engineer regarding proper ventilation if installed indoors or in an enclosed area.
  - People with infectious diseases should not use a spa to avoid water contamination, which could result in spreading infections to others.
  - Always shower before and after using your spa. Maintain water chemistry in accordance with manufacturer's instructions. Failure to do so may result in contracting a waterborne illness (e.g. an infection, bacteria or virus).
11.  **WARNING:** In addition to maintenance of filters and water chemistry, proper ventilation is recommended to reduce the risk of contracting a waterborne illness (e.g. an infection, bacteria or virus) and/or respiratory ailments that could be present in the air or water. Consult a licensed architect or building contractor to determine your specific needs if installing your hot tub indoors.
12. **CAUTION: TO DECREASE RISK OF PRODUCT DAMAGE.**
- Maintain water chemistry in accordance with manufacturer's instructions.
  - Proper chemical maintenance of spa water is necessary to maintain safe water and prevent possible damage to spa components.
13.  **WARNING: RISK OF SEVERE INJURY OR DEATH!** The appliance is not intended for use by persons (including children) with reduced physical, sensory or mental capabilities, or lack of experience or knowledge, unless they have been given supervision or instruction concerning use of the appliance by a person responsible for their safety.

**14. NOTE:** This spa is not intended nor designed to be used in a commercial or public application. The spa buyer shall determine whether there are any code restrictions on the use or installation of this spa since local code requirements vary from one locality to another.

### **Hot Tub Safety Literature**

To ensure you have a safe and enjoyable hot tub experience, learn all you can about hot tub safety and emergency procedures.

The Pool & Hot Tub Association has a great source of safety literature.

Go to <http://phta.org>

Conduct your own search on the internet.

Write to the following address:

Pool & Hot Tub Association

2111 Eisenhower Avenue

Alexandria VA 22314

703.838.0083

## Entrapment Risk





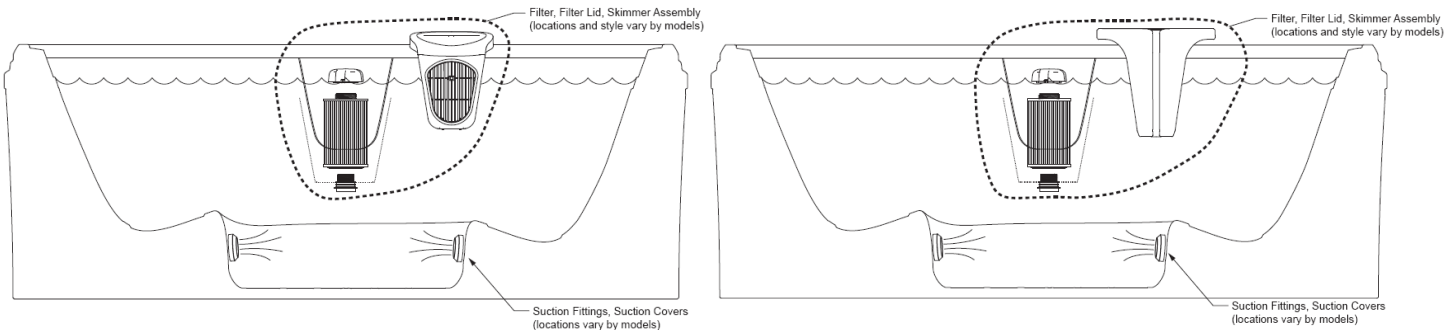

The Consumer Products Safety Commission/USA has reported that users of pools and spas have become entrapped (stuck) to drain and/or suction fittings causing death, drowning, or serious injury (see diagram below). This spa was manufactured to meet the standards and specifications outlined in the "Virginia Graeme Baker Pool and Spa Safety Act" (VGB Safety Act). Entrapment risk can be minimized if proper precautions are taken.



**DANGER: RISK OF PERSONAL INJURY OR DEATH!**  
Never operate the spa if a suction fitting, suction cover, filter, filter lid or skimmer assembly are broken, damaged or missing.



**Note: Suction covers must be replaced every 7 years.**

1.  **DANGER: RISK OF SEVERE INJURY OR DROWNING! Hair entrapment:** May occur if hair is entangled, knotted or snagged in a drain suction or skimmer assembly. This has been reported in persons who when submerge themselves underwater, allowing hair to come close and/or within the reach of the suction fittings, suction covers or skimmer assembly.
  - Keep hair away from suction fittings, suction covers, filter, filter lid or skimmer assembly.
  - Children are at risk for hair entrapment if swimming under water.
  - Never allow children to play or get near the suction fittings, suction covers, filter, filter lid or skimmer assembly.
2.  **DANGER: RISK OF SEVERE INJURY OR DROWNING! Limb entrapment:** May occur when a limb becomes entrapped, inserted or sucked into a suction or outlet opening.
  - Always keep suction fittings, suction covers, filter, filter lid or skimmer assembly in place when operating to avoid limb entrapment.
  - Never allow children to play or get near the suction fittings, suction covers, filter, filter lid or skimmer assembly.
3.  **DANGER: RISK OF SEVERE INJURY OR DROWNING! Body entrapment:** 
  - Do not insert fingers in massage jet
4.  **DANGER: RISK OF SEVERE INJURY OR DROWNING! Body entrapment:** May occur when part of the torso becomes entrapped, inserted or sucked into a suction or outlet opening.
  - Never allow children to play or get near the suction fittings, suction covers, filter, filter lid or skimmer assembly.
5.  **DANGER: RISK OF SEVERE INJURY OR DROWNING! Evisceration (disembowelment) entrapment:** May occur when the buttocks become entrapped, inserted or sucked into a suction or outlet opening.
  - Never sit on suction fittings, suction covers, filter, filter lid or skimmer assembly.
  - Never allow children to play or get near the suction fittings, suction covers, filter, filter lid or skimmer assembly.
6.  **DANGER: RISK OF SEVERE INJURY OR DROWNING! Mechanical entrapment:** May occur when jewelry, swimsuit, or hair accessories become entangled, knotted or snagged in a drain suction or skimmer assembly.
  - Never allow your jewelry, swimsuit, or hair accessories to come close to the suction fittings, suction covers or skimmer assembly.
  - Never allow children to play or get near the suction fittings, suction covers, filter, filter lid or skimmer assembly.

## Hyperthermia

Prolonged immersion in hot water may induce hyperthermia (overheating). The use of alcohol or drugs can greatly increase the risk of fatal hyperthermia in spas. A description of the causes, symptoms, and effects of hyperthermia are as follows:

Hyperthermia occurs when the internal temperature of the body reaches a level several degrees above the normal body temperature of 37°C (98.6°F). The symptoms of hyperthermia include drowsiness, lethargy (fatigue), and an increase in the internal temperature of the body (feeling of being too hot). The effects of hyperthermia include:

- Unawareness of impending hazard.
- Failure to perceive heat.
- Failure to recognize the need to exit spa.
- Physical inability to exit spa.
- Fetal damage in pregnant women; and
- Unconsciousness and DANGER of drowning.

## Important Additional Safety Instructions

When using this electrical equipment, basic safety precautions should always be followed, including the following:

- 1. READ AND FOLLOW ALL INSTRUCTIONS.**
2. Permanently installed units: A green colored terminal or a terminal marked G, Gr, Ground, Grounding or the  symbol\* is located inside the supply terminal box or compartment. To reduce the risk of electric shock, this terminal must be connected to the grounding means provided in the electric supply service panel with a continuous copper wire equivalent in size to the circuit conductors that supply this equipment (\*IEC Publication 417, Symbol 5019).
3. A grounding bar is provided on the outside of the equipment box. To reduce the risk of electric shock, connect the local common bonding grid in the area of the spa to this grounding bar with an insulated or bare copper conductor not smaller than 10 mm<sup>2</sup> (No. 6 AWG).
4. All field installed metal components such as rails, ladders, drains or other similar hardware within 3m (10 feet) of the spa shall be bonded to the equipment grounding buss with copper conductors not smaller than 10 mm<sup>2</sup> (No. 6 AWG).
- 5. SAVE THESE INSTRUCTIONS.**



## Choosing A Location

**IMPORTANT:** Because of the combined weight of the spa water and users, it is extremely important that the base upon which the spa rests be smooth, flat, level and capable of uniformly supporting this weight, without shifting or settling, for the entire time the spa is in place. If the spa is placed on a surface which does not meet these requirements, damage to the skirt and/or the spa shell may result. Damage caused by improper support is not covered under warranty. It is the responsibility of the spa owner to assure the integrity of the support over time. We recommend a poured, reinforced concrete slab with a minimum thickness of 10 cm (4 inches). Wood decking is also acceptable provided it is constructed so that it meets the requirements outlined above.



**WARNING:** For spas that are to rest on balconies, roofs or other platforms not specifically tied into main structural support, consult a professional Structural Engineer with experience in this type of application.



**WARNING:** Proper drainage is required. The installation must not allow the spa equipment bay to become flooded or wetted (by external water). It is your responsibility, and the responsibility of any installation contractor you hire, to make sure that all applicable codes and/or local construction requirements are met. If in doubt, refer to the building authority responsible for approving the proposed installation site.

The spa must be installed in such a manner as to provide drainage away from it. Placing the spa in a depression without provisions for proper drainage could allow rain, overflow, leaks from spa plumbing, and other casual water to flood the equipment and create a wet condition in which it would sit in. For spas which will be installed below grade or recessed into a floor or deck, install so as to permit access to the equipment, either from above or below, for servicing. Make certain that there are no obstructions which would prevent removal of all cabinet side panels and access to the jet components, especially on the side with the equipment bay.

**CAUTION:** If the spa is indoors or located in an enclosed area, proper ventilation should be discussed with an Engineer or authority competent enough to understand the necessary provisions needed to vent moist or heated air and air associated with chemical odors outdoors. **When the spa is in use considerable amounts of moisture will escape potentially causing mold and mildew.** This can cause health risk. Over time, this can damage certain surfaces, surroundings, and equipment.

### Outdoor Location

In selecting the ideal outdoor location for your spa, we suggest that you take into consideration:

- The proximity to changing area and shelter (especially in colder weather).
- The pathway to and from your spa (this should be free of debris so that dirt and leaves are not easily tracked into the spa).
- The closeness to trees and shrubbery (remember that leaves and birds could create extra work in keeping the spa clean).
- Asheltered environment (less wind and weather exposure can result in lowered operation and maintenance costs).
- The overall enhancement of your environment. It is preferable not to place the spa under an unguttered roof overhang since run-off water will shorten the life expectancy of the spa cover.
- For spas that are to rest on balconies, roofs or other platforms not specifically tied into main structural support, consult a professional Structural Engineer with experience in this type of application.
- In the unlikely event that you should ever need to access or gain entry to any portion of the spa for servicing, it is highly recommended that you plan your outdoor installation to provide full access to the entire spa. Please take this into consideration when placing the spa in a deck or enclosed by a surrounding.
- Consider locating your spa away from any reflective surface or glass to prevent any damage to the spa and cabinet.
- Do not shim the spa. To ensure proper support the spa must sit flat on the intended foundation.

## Indoor Location

For indoor installations many factors need to be considered before installing a spa indoors:



**WARNING:** In addition to maintenance of filters and water chemistry, proper ventilation is recommended to reduce the risk of contracting a waterborne illness (e.g. an infection, bacteria or virus) and/or respiratory ailments that could be present in the air or water. Consult a licensed architect or building contractor to determine your specific needs if installing your hot tub indoors.

- **Proper Foundation:** Consult a Structural Engineer when considering a foundation that will adequately support the spa the entire time it is in place. Proper support is critical especially if the spa is to rest on a second story or higher. For spas that are to rest on balconies, roofs or other platforms not specifically tied into the main structural support, you should consult a professional Structural Engineer with experience in this type of application.
- **Proper Drainage:** It is extremely important to have in place measures to sufficiently handle excessive water spillage. Be sure the flooring in which the spa rests on has adequate drainage and can handle the entire contents of the spa. Be sure to make provisions for ceilings and other structures that may be below the spa's installation. Areas around your spa can become wet or moist so all flooring and subsequent furniture, walls and adjacent structures should be able to withstand or resist water and moisture.
- **Proper Ventilation:** Proper ventilation should be discussed with an Engineer or authority competent enough to understand the necessary provisions needed to vent moist or heated air and air associated with chemical odors outdoors. When the spa is in use considerable amounts of moisture will escape, potentially causing mold and mildew over time which can damage certain surfaces and/ or surroundings.
- **Sufficient Access:** In the unlikely event that you should ever need to access or gain entry to any portion of the spa for servicing, it is highly recommended that you plan your indoor installation to provide full access to the entire spa.
- **Warranty:** Damage caused by not following these guidelines or any improper installation not in accordance to local codes or authorities is not covered under the spas warranty. Please consult your local state or city building ordinances.
- **Do not shim the spa.** To ensure proper support the spa must sit flat on the intended foundation.

## Spa Cover Installation

**WARNING:** AVOID DROWNING RISK Failure to follow instructions may result in injury or drowning.

- Non-secured covers are a hazard.
- Keep children away. People or objects cannot be seen under the cover.
- Because of entrapment possibility, remove cover completely before entry of bathers.
- Excess weight can break the insulating foam, bend the steel reinforcement and damage the cover. Do not allow people or pets to stand or sit on the cover. Do not allow loads such as snow, leaves or anything else to accumulate on the cover. Do not use the cover as a table.

Caution, to avoid damage to the cover always remove the cover while adding chemicals to the spa water. This will prevent damaging chemical vapors from being trapped under the spa cover. These vapors can prematurely damage the cover material and void the warranty.

When properly installed, the cover supplied with your spa meets the Manual Safety Cover requirements of ASTM F1346-91.

If you are installing your spa near a wall or with any type of structure on the outside, such as a gazebo, remember to allow access for cover removal.

To deter entrapment by somebody slipping under the cover, ensure that all latches supplied with the cover are securely screwed to the cabinet, straps are inserted into the latches, the latches are locked, and the key is kept in a secure location.

Keep the spa covered when not in use to deter entry by unauthorized persons, reduce the loss of heat, and keep out rain and to keep foreign materials from settling in the water.

### Follow these steps to properly install the cover.

1. Place the spa cover on top of the spa. Ensure the cover flaps and straps are not under the cover. Ensure the cover is properly seated in its final position.
2. Each strap is supplied with a cabinet latch snapped in place. Leave the cabinet latches at the end of the straps, but remove the bag containing the screws and while lightly pulling downward on a strap, mark the center bottom of the latch (Fig 1). A piece of tape may be a good method to do this. Mark each remaining strap in the same way.
3. Remove the strap by pinching the two barbs of the strap as indicated (Fig 2).
4. Hold the cabinet latch on the mark and using a Phillips screwdriver, drive three screws through the holes in the cabinet latch and into the outside of the spa (Fig 3).
5. While the spa is not in use place the cover on top of the spa and snap all straps into the cabinet latches. To further protect against entry, lock each latch by quarter turning the key clockwise (Fig 4). Store the key in a secure place.

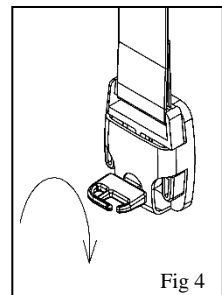
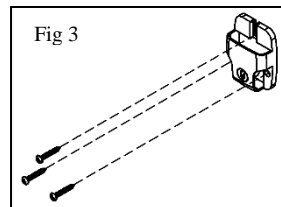
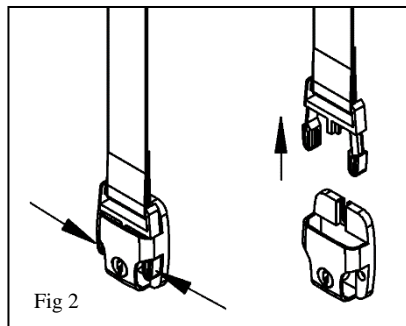
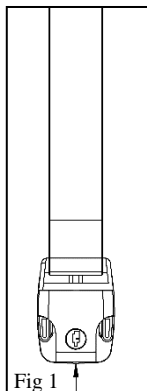

## Filling Your Spa

### **WARNING: RISK OF PERSONAL INJURY!**

- To decrease the risk of injury, drowning or entrapment, never leave your hot tub unattended for any reason while the cover is open and accessible, especially to small children and animals!
- Precautions should be taken to minimize your exposure to chemical vapors (that could cause lung, brain, or skin damage).

### **CAUTION: TO DECREASE BUILD UP ON COMPONENTS AND MINIMIZE SURFACE DAMAGE.**

Never fill with water from a water softener. If your water is extremely “hard,” it is preferable to fill half-way with hard water and the rest of the way with softened water. Water that is too soft can be corrosive to metal components.

### **CAUTION:** Your spa is constructed of a very resilient and flexible polymeric material. It is designed to flex as much as 2 inches (5cm) without damage. However, overfilling the spa and/or installing on a non-level surface for extended periods of time can permanently distort the original shape of your spa, cause structural damage, effect the sealing of the cover and void your warranty.

## TO FILL THE SPA

Remove the access panel and ensure the drain valve is closed and the cap is secure (Fig 5).

Place a garden hose into filter area (Fig 7) and fill the spa with cold (never warm or hot) water 15 to 20 cm (6 to 8 inches) below the top edge of the spa (Fig 6). If there is not enough water in your spa, the pump may suck air into the plumbing system thereby damaging the pump or heater and void the warranty. Do not overfill, as the spa’s water level will rise as each person enters the spa. Always keep the spa water level above the jet openings.

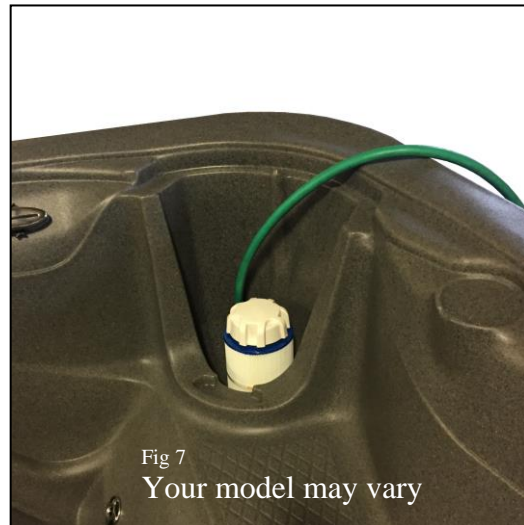
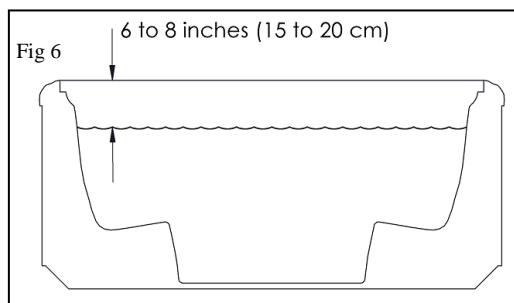
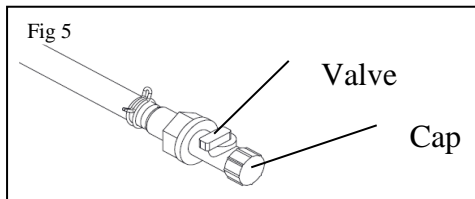

## Draining the spa

### **WARNING: RISK OF PERSONAL INJURY!**

- To decrease the risk of injury, drowning or entrapment, never leave your hot tub unattended for any reason while the cover is open and accessible, especially to small children and animals!
- Precautions should be taken to minimize your exposure to chemical vapors (that could cause lung, brain, or skin damage).

Draining your spa on a regular basis rids the spa of dissolved solids and protects your spa equipment from the effects of residual calcium hardness and total alkalinity problems. Depending upon usage, it may be as often as every three months.

To drain the spa, follow these steps:

1. Turn power off to the spa.
2. Remove the access panel and locate the drain valve (Fig 5).
3. Ensure that the drain valve is in the off position (as shown in Fig 5). Remove the cap (Fig 5) and attach a standard garden hose to the drain valve (Fig 8).

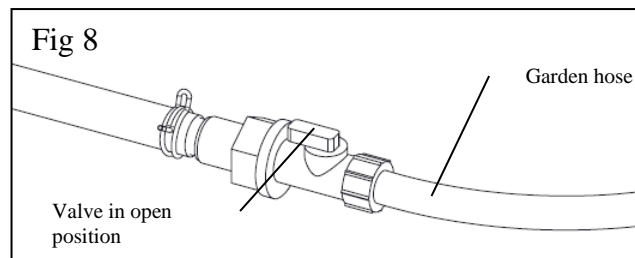

4. Route the garden hose to a sewer drain capable of safely assimilating 1135 liters (300 plus gallons) of water which may contain both unsanitary contaminants and chemical residue. Open the drain valve (as shown in Fig 8). The spa drains slowly.
5. The spa can only drain to the lowest jet. It may be necessary to manually remove the remaining water.
6. Before refilling your spa, ensure that the drain valve is in the off position and the cap is secured (Fig 5).

## FOR THE ELECTRICIAN two pump (5H3)

Installations that do not adhere to these instructions can expose users to electric shock and will void the warranty.

Electrical connections must be made by a licensed certified electrician.

The power supply must be protected by an RCD having a rated residual operating current not exceeding 30 mA and a means for disconnection must be incorporated in the fixed wiring in accordance with all wiring rules.

Power requirements

230 VAC, 1PH, 50HZ, 32 AMPS (40 AMP CIRCUIT BREAKER)

3 WIRE (LINE, NEUTRAL, GROUND)

To make electrical connections, remove the access door as shown in Fig 5. Locate the control box, remove the cover and make connections.

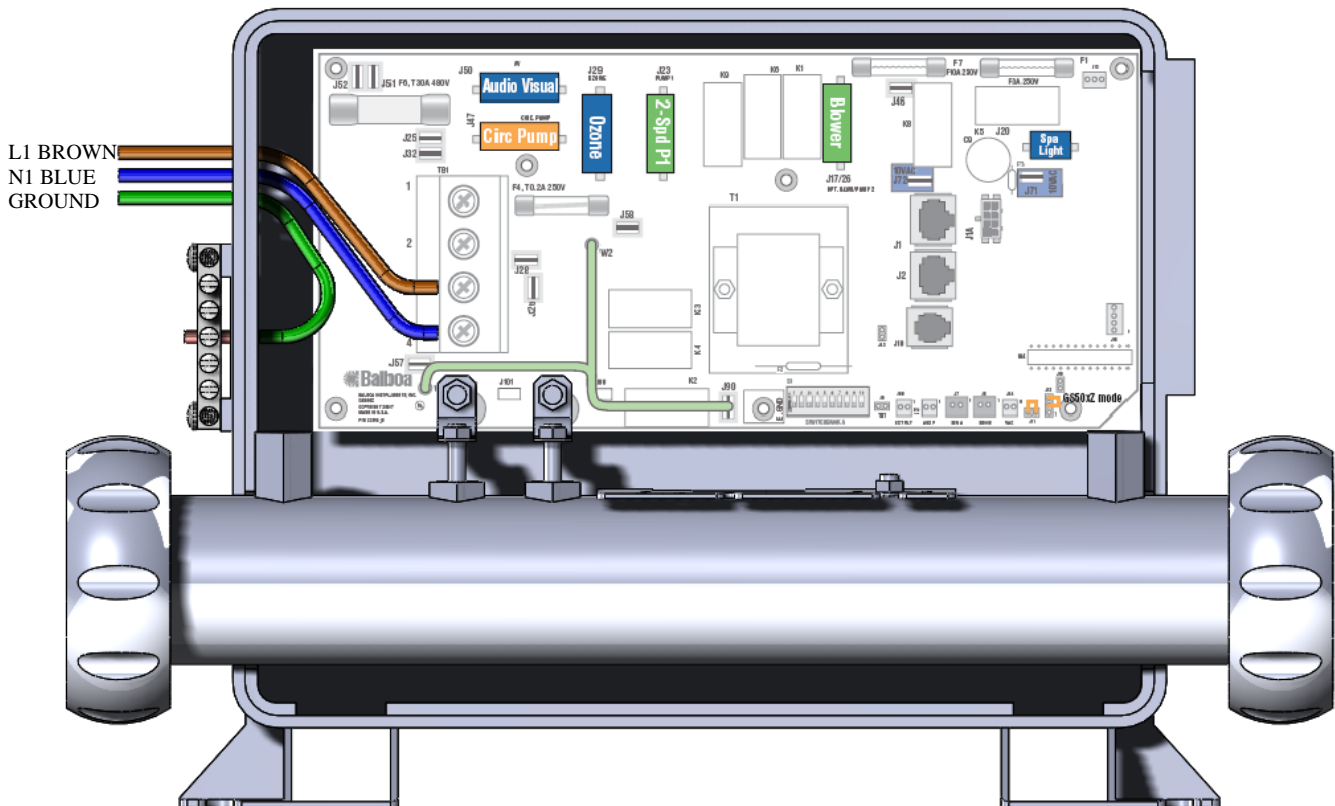
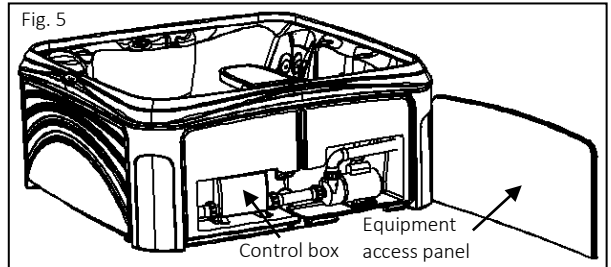

**FOR THE ELECTRICIAN two pump (5H3) continued**

DIP SETTINGS GS501Z, 54511-01

MAIN POWER TO SYSTEM MUST BE TURNED OFF BEFORE ADJUSTING DIP SWITCHES

<p><b>DIP SETTINGS</b></p> 	TEST MODE OFF	← 1	TEST MODE ON
	STD, ECON, SLEEP ALLOWED	2 →	STANDARD MODE ONLY
	DUPLEX PANEL	3 →	MINI PANEL
	N/A MUST BE OFF	← 4	N/A MUST BE OFF
	N/A MUST BE OFF	← 5	N/A MUST BE OFF
	60HZ OPERATION	6 →	50HZ OPERATION
	TWO PUMPS	← 7	ONE PUMP
	DEGREES FAHRENHEIT	8 →	DEGREES CELSIUS
	N/A MUST BE OFF	← 9	N/A MUST BE OFF
	HIGH AMP – HEAT W/P1 HI	← 10	LOW AMP – NO HEAT W/P1 HI

## System Operation two pump (5H3)

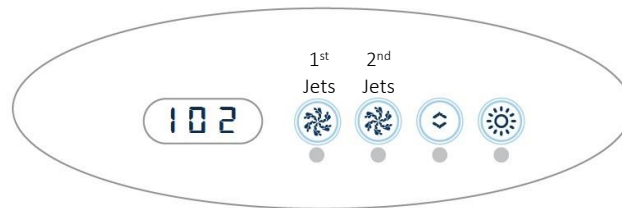

### Initial Start-Up

When electrical power is first supplied to your spa, the control system will display a series of numbers followed by **Pr**, then **-- --**. At this point the circulation pump will be activated and operate for 7 minutes as it seeks to prime the pump. If the spa was filled as described on page 12, the pump will usually prime without a problem. However, if after 7 minutes, water is not flowing from the jets, you may need to purge the pump manually. Please see page 31 for how to manually purge the pump.

Please note that when electrical power is first supplied to the spa, the spa's internal clock starts. This begins the first 12-hour period in which the selected filtration cycle will operate. The preset cycle is one hour (F1). Please see **Spa Water Maintenance**, below.

Also please note that upon initial start-up, temperature adjustment is preset to heat up to 37° C (100° F). Please see **Temperature Adjustment** below if you wish to choose a different setting.

### Temperature Adjustment

The temperature adjustment range is 26°C to 40°C when displayed in Celsius. When displayed in Fahrenheit the range is 80°F to 104°F.

The control's display will constantly show the spa's water temperature. To adjust the spa's water temperature, press the button. The display will show the current set temperature and flash. To change the set temperature, press the button a second time before the display stops flashing. Each press of the button will continue to either raise or lower the set temperature. If the opposite direction is desired, allow the display to revert to the current water temperature. Press the button to display the set temperature, and again to make the temperature change in the desired direction. After you have set the desired temperature, stop pressing the button, the display will stop flashing after five seconds and the current spa temperature will show again.

### 1<sup>st</sup> Jets

Press the 1<sup>st</sup> jets button to power the 1st jet pump. Press again to turn it off. If left running, the high flow pump will automatically turn off after 15 minutes.

### 2<sup>nd</sup> Jets

Press the 2<sup>nd</sup> jets button to power 2<sup>nd</sup> jet pump. This pump will sequence with each press of the 2<sup>nd</sup> jets button as follows: low flow – high flow – off. If left running, the high flow pump will automatically turn off after 15 minutes (low flow in 4 hours).

### Adjustable LED Light

To turn the light on, press the button. Press again to turn it off. To adjust the color modes, press the button immediately after turning it off. The light will come back on in a new color mode. Each time you repeat this procedure, the light will cycle to a new color mode, as shown below. If left on, the light will automatically turn off after four hours.

1. Color wheel. The light will slowly blend cycle through the colors.
2. Aqua white.
3. Light blue.
4. Violet.
5. Dark blue.
6. Light green.
7. Dark green.
8. Red.
9. Step sequence through the colors.
10. Very slow color wheel.
11. Back to #1.



## Two-pump (PU2) models, Additional Functions

### Spa Water Maintenance

#### Spa Water Maintenance

This function enables you to program the amount of water filtration time.

Press  then the 2<sup>nd</sup> jets  button to enter the programming mode.

Once in the programming mode press  to select the filtration time: **F1** through **F8** per the chart below.

Code	F1	F2	F3	F4	F5	F6	F7	F8
Hours of filtering every 12 hours	1	2	3	4	5	6	7	8

To exit press the 2<sup>nd</sup> jets  button.

### Spa heating modes





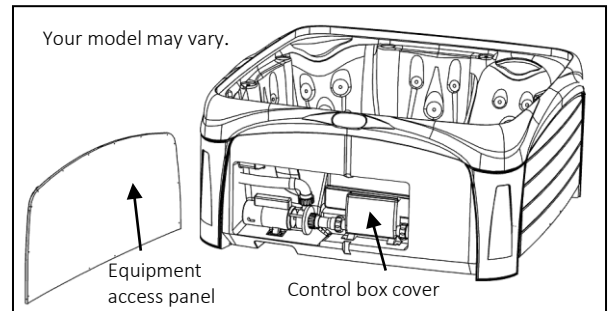

Your spa is factory set to Standard Heating (ST) mode. This mode operates the heater whenever needed to maintain the programmed spa water temperature. (See Temperature Adjustment page 16).

#### Advanced Optional Settings

You have the option to enable other heating modes as explained below: standard, economy and sleep. To enable these heating modes, you must do the following steps.

1. Turn off power to the spa.
2. Using a Philips screwdriver, remove the equipment access panel as shown.
3. Remove the control box cover by removing the two bottom screws, slide the cover up and then pull forward.
4. Slide dip switch 2 to the *off* position. See page 15 for reference.
5. Reinstall the control box cover and the equipment access panel, before turning the power on.



These heating modes offer the ability to control your heater in one of three ways: standard, economy or sleep. Your spa is preset at the factory to Standard Mode. However, the Standard Heating Mode can be changed to Economy or Sleep by pressing  then . With each pressing of  then , the display will cycle through the three different modes described below. Note: by pressing  then , you will not see the heating mode the spa is currently set to, but rather it will advance to the next mode. It is the last mode seen in the display that will be the new heating mode setting.

- **Standard Mode (St):** Your spa is preset to this mode. This mode operates the heater whenever needed to maintain the programmed spa water temperature. (See Temperature Adjustment page 16).
- **Economy Mode (Ec):** This mode operates the heater only during programmed Filtering Cycles (See Spa Water Filtration Settings above). This mode is ideal for areas that charge a premium for electricity during peak hours. This mode will maintain the thermostat setting. If it does not reach the thermostat setting, you may have to allow for more heating time by increasing the filtration cycles.
- **Sleep Mode (SL):** This mode works in the same manner as the Economy Mode except the thermostat setting is automatically lowered by 20 degrees. This mode is best suited for extended leaves from home when it is not important to maintain constant water temperature, such as vacations or business trips.

### Summer Set Temperature

In extremely hot weather, it is possible for water temperature to exceed the temperature setting. This is especially common when your temperature setting is lower than air temperature. If the water temperature exceeds the temperature setting more than 1.5°C (3°F), the pump will stop running automatically except during filter cycles. Normal operation will resume when the water temperature cools to below the setting, or the setting is increased above the water temperature.

## FOR THE ELECTRICIAN one pump (5H2)

Installations that do not adhere to these instructions can expose users to electric shock and will void the warranty.

Electrical connections must be made by a licensed certified electrician.

The power supply must be protected by an RCD having a rated residual operating current not exceeding 30 mA and a means for disconnection must be incorporated in the fixed wiring in accordance with all wiring rules.

### Power requirements

230 VAC, 1PH, 50HZ, 20/32 AMPS (see below)

3 WIRE (LINE, NEUTRAL, GROUND)

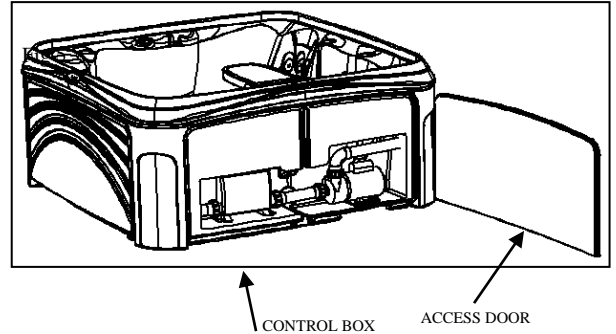

**The low amp rating is 16 amps (20-amp circuit).** The number 10 dip switch (see next page) is set to the “on” position. In this setting the heater will operate only while the circulation pump (low speed) is running. The heater will not run while the jet pump (high speed) is running. The low amp circuit may be needed where there is limited available power, as seen in some older homes. This means the water will begin to cool while using the jet pump. Many find this adequate due to their mild climate or shorter length of usage.

**The high amp rating is 24 amps (32-amp circuit).** The number 10 dip switch (see next page) is set to the “off” position. In this setting the heater will operate while the jet pump is running.

To make electrical connections, remove the access door as shown in Fig 5. Locate the control box, remove the cover and make connections.

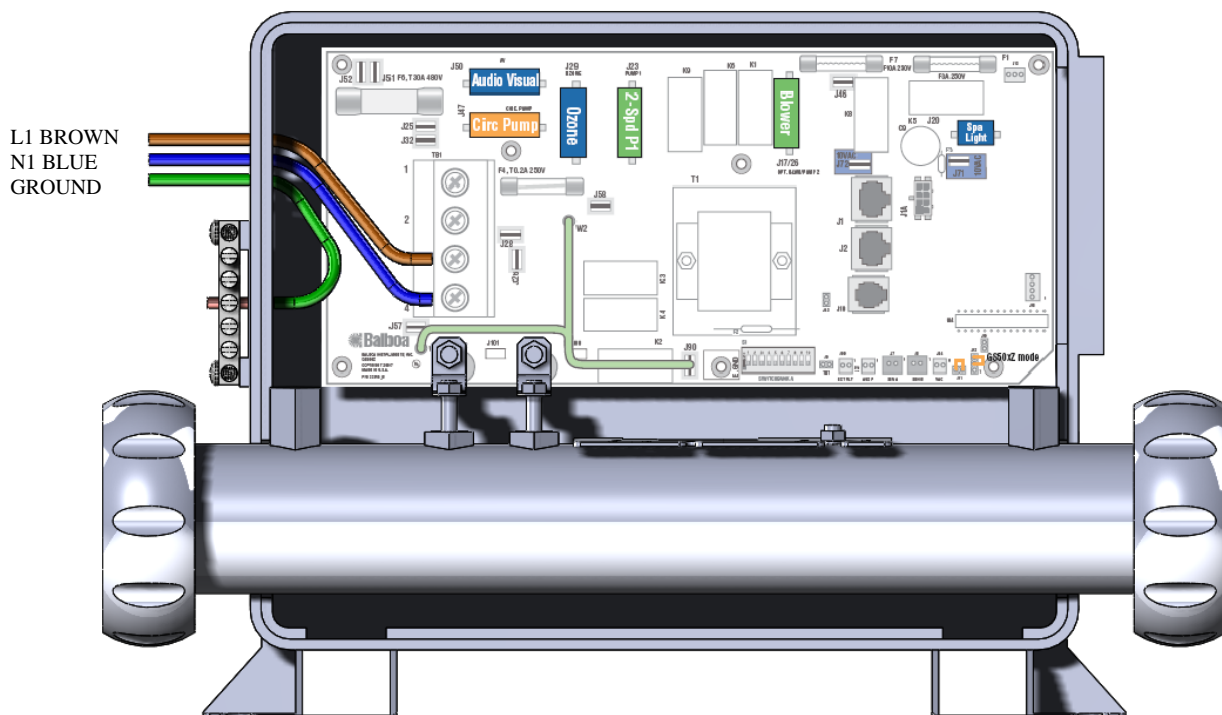

**FOR THE ELECTRICIAN One pump (5H2) (continued)**

DIP SETTINGS 54509-01

MAIN POWER TO SYSTEM MUST BE TURNED OFF BEFORE ADJUSTING DIP SWITCHES

TEST MODE OFF	← 1	TEST MODE ON
POLL EVERY 30 MINS	2 →	POLL EVERY 90 MINS
DUPLEX PANEL	3 →	MINI PANEL
N/A MUST BE OFF	← 4	N/A MUST BE OFF
N/A MUST BE OFF	← 5	N/A MUST BE OFF
60HZ OPERATION	6 →	50HZ OPERATION
STD, ECON, SLEEP ALLOWED	7 →	STANDARD MODE ONLY
DEGREES FAHRENHEIT	8 →	DEGREES CELSIUS
N/A MUST BE OFF	← 9	N/A MUST BE OFF
HIGH AMP – HEAT W/P1 HI 24 AMP RATING (32 AMP CIRCUIT)	10 →	LOW AMP – NO HEAT W/P1 HI 16 AMP RATING (20 AMP CIRCUIT)

## System Operation, One pump (5H2)

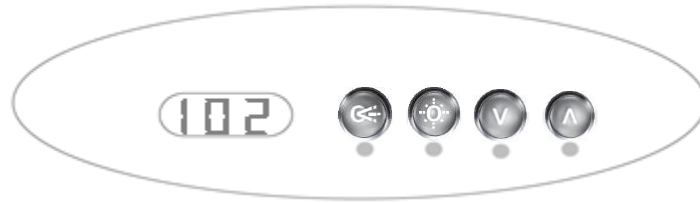

### Initial Start-Up



When electrical power is first supplied to your spa, the control system will display a series of numbers followed by **Pr**, then -- --. At this point the circulation pump will be activated and operate for 7 minutes as it seeks to prime the pump. If the spa was filled as described on page 12, the pump will usually prime without a problem. However, if after 7 minutes, water is not flowing from the jets, you may need to purge the pump manually. Please see page 31 for how to manually purge the pump.

Please note that when electrical power is first supplied to the spa, the spas internal clock starts. This begins the first 12-hour period in which the selected filtration cycle will operate. The preset cycle is one hour (F1). Please see **Spa Water Maintenance**, below.



Also please note that upon initial start-up, temperature adjustment is preset to heat up to 37° C (100° F). Please see **Temperature Adjustment** below if you wish to choose a different setting.

### Temperature Adjustment



The temperature adjustment range is 26°C to 40°C when displayed in Celsius. When displayed in Fahrenheit the range is 80°F to 104°F.

The control's display will constantly show the spa's water temperature. To adjust the spa's water temperature, press  or . The display will flash and show the current temperature setting. Each time either one of these buttons are pressed, the temperature setting will change by 1°. After you have set the desired temperature, stop pressing the buttons, the display will stop flashing after five seconds and the current spa temperature will show again.

### Jets

Press the  pad to power the pump. The pump will sequence with each press of the  button as follows: low flow – high flow – off. If left running, the high flow pump will automatically turn off after 15 minutes (low flow in two hours).

### Adjustable LED Light

To turn the light on, press the  button. Press again to turn it off. To adjust the color modes, press the  button immediately after turning it off. The light will come back on in a new color mode. Each time you repeat this procedure, the light will cycle to a new color mode, as shown below. If left on, the light will automatically turn off after four hours.

1. Color wheel. The light will slowly blend cycle through the colors.
2. Aqua white.
3. Light blue.
4. Violet.
5. Dark blue.
6. Light green.
7. Dark green.
8. Red.
9. Step sequence through the colors.
10. Very slow color wheel.
11. Back to #1.

### Spa Water Maintenance

This function enables you to program the amount of water filtration time.

Press or then to enter the programming mode.

Once in the programming mode press or to select the filtration time: **F1** through **F8** per the chart below.

Code	F1	F2	F3	F4	F5	F6	F7	F8
Hours of filtering every 12 hours	1	2	3	4	5	6	7	8

To exit press .

### Spa heating modes

Your spa is factory set to Standard Heating (ST) mode. This mode operates the heater whenever needed to maintain the programmed spa water temperature. (See Temperature Adjustment page 20).

### Advanced Optional Settings

You have the option to enable other heating modes as explained below: standard, economy and sleep. To enable these heating modes, you must do the following steps.

1. Turn off power to the spa.
2. Using a Philips screwdriver, remove the equipment access panel as shown.
3. Remove the control box cover by removing the two bottom screws, slide the cover up and then pull forward.
4. Slide dip switch 7 to the *off* position. See page 19 for reference.
5. Reinstall the control box cover and the equipment access panel, before turning the power on.

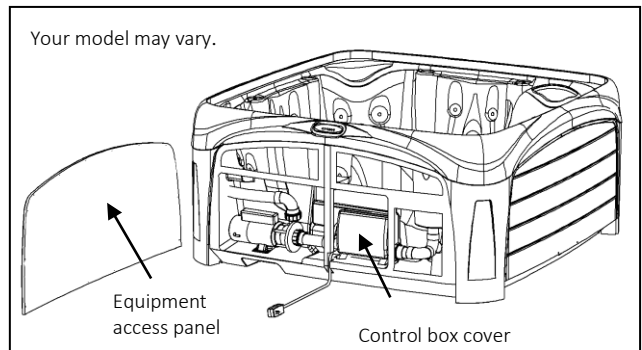

These heating modes offer the ability to control your heater in one of three ways: standard, economy or sleep. Your spa is preset at the factory to Standard Mode. However, the Standard Heating Mode can be changed to Economy or Sleep by pressing then . With each pressing of then , the display will cycle through the three different modes described below. Note: by pressing then , you will not see the heating mode the spa is currently set to, but rather it will advance to the next mode. It is the last mode seen in the display that will be the new heating mode setting.

- **Standard Mode (St):** Your spa is preset to this mode. This mode operates the heater whenever needed to maintain the programmed spa water temperature. (See Temperature Adjustment page 20).
- **Economy Mode (Ec):** This mode operates the heater only during programmed Filtering Cycles (See Spa Water Filtration Settings above). This mode is ideal for areas that charge a premium for electricity during peak hours. This mode will maintain the thermostat setting. If it does not reach the thermostat setting, you may have to allow for more heating time by increasing the filtration cycles.
- **Sleep Mode (SL):** This mode works in the same manner as the Economy Mode except the thermostat setting is automatically lowered by 20 degrees. This mode is best suited for extended leaves from home when it is not important to maintain constant water temperature, such as vacations or business trips.

### Summer Set Temperature

In extremely hot weather, it is possible for water temperature to exceed the temperature setting. This is especially common when your temperature setting is lower than air temperature. If the water temperature exceeds the temperature setting more than 1.5°C (3°F), the pump will stop running automatically except during filter cycles. Normal operation will resume when the water temperature cools to below the setting, or the setting is increased above the water temperature.

Display Messages, Both one (5H2) & two pump (5H3) systems

MESSAGE	MEANING	ACTION REQUIRED
	No message on display. Power has been cut off to the spa.	The control panel will be disabled until power returns. Spa settings will be preserved until next power up.
--	Temperature unknown.	After the pump has been running for one minute, the temperature will be displayed.
H H	Overheat -The spa has shut down. One of the sensors has detected 118°F (47°C) at the heater.	<b>DO NOT ENTER THE WATER.</b> Remove the spa cover and allow water to cool. Once the heater has cooled, reset by pushing any button. If spa does not reset, shut off the power to the spa and call your dealer or service organization.
O H	Overheat" -The spa has shut down. One of the sensors has detected that the spa water is 110°F (43°C).	<b>DO NOT ENTER THE WATER.</b> Remove the spa cover and allow water to cool. At 107°F (41°C), the spa should automatically reset. If spa does not reset, shut off the power to the spa and call your dealer or service organization
1 C	Ice -Potential freeze condition detected.	No action required. The pump will automatically activate regardless of spa status.
S A	Spa is shut down. The sensor that is plugged into the "A" jack is not working.	If the problem persists, contact your dealer or service organization. (May appear temporarily in an overheat situation and disappear when the heater cools.)
S b	Spa is shut down. The sensor that is plugged into the "B" jack is not working.	If the problem persists, contact your dealer or service organization. (May appear temporarily in an overheat situation and disappear when the heater cools.)
S n	Sensors are out of balance. If alternating with spa temperature, it may just be a temporary condition. If flashing by itself, spa is shut down.	If the problem persists, contact your dealer or service organization.
H L	A significant difference between temperature sensors has been detected. This could indicate a flow problem.	Check water level in spa. Refill if necessary. If the water level is okay, make sure the pumps have been primed. If problem persists, contact your dealer or service organization.
L F	Persistent low flow problems. (Displays on the fifth occurrence of "HL" message within 24 hours.) Heater is shut down, but other spa functions continue to run normally.	Follow action required for "HL" message. Heating capability of the spa will not reset automatically; you may press any button to reset.
dr	Possible inadequate water, poor flow, or air bubbles in the heater. Spa is shut down for 15 minutes.	Water level in spa. Refill if necessary. If water level is okay, make sure the pumps have been primed. Press any button to reset, or this message automatically will reset within 15 minutes. If problem persists, contact your dealer or service organization.
dY	Water detected in heater. (Displays on third occurrence of "DR" message.) Spa is shut down.	Follow action required for "dr" message. Spa will not automatically reset. Press any button to reset.

## SKIMMER FILTER CLEANING OR REPLACEMENT OF THE FILTER CARTRIDGE



The spa's automatic surface skimmer filter is designed to remove floating debris and contaminants, such as body lotions, by drawing water through a specially formulated filter cartridge element. It is critical that this element be routinely cleaned.



### To Clean or Replace the Filter Cartridge

1. **Disconnect the electrical power.** Never operate the spa without the filter cartridge in place. It is difficult to remove the filter cartridge while the water is flowing. Also, there is a risk that debris may be drawn into the plumbing system, damage the pump and void the warranty.
2. Remove the skimmer cover.
3. Remove the end nut by turning it counterclockwise.
4. Pull the filter cartridge straight up and out of the skimmer filter.
5. At this point you can either clean the filter cartridge filter or install a new filter cartridge. To clean the filter cartridge, take it to an area where the runoff drains to a sewer drain capable of safely assimilating the water which may contain both unsanitary contaminants and chemical residue. Thoroughly rinse with the high pressure from a garden hose until the filter cartridge is free of dirt and debris.
6. Return the cleaned or new filter cartridge to the filter well and thread the end nut clockwise until snug against the top of the filter cartridge. Reinstall the skimmer cover before reconnecting the electrical power.

### Air Injection Venturi Adjustment

Air injection into the jet's water stream is adjusted by turning the venturi dials. Each dial is independent and controls about half of the jets, respectively. Turn them counter-clockwise to increase, and clockwise to decrease, the amount of air injected into the jets' water stream.



### Adjustable Water Flow Jets

The jet's water flow is adjusted by turning the jet face. Each jet's flow is adjusted independently. Turn the jet face counter-clockwise to increase, and clockwise to decrease, the amount of water flow of each jet.



### Waterfall Flow Adjustment

Turn the dial counter-clockwise to increase, and clockwise to decrease, the amount of water flow of the waterfall.

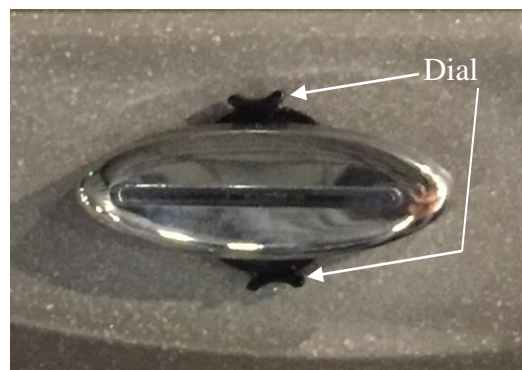



## Water Chemistry

Spa water chemistry (or water balance) affects the safety of your equipment as well as the appearance of your spa water. Water balance has five factors: pH, total alkalinity, calcium hardness, temperature and total dissolved solids. The pH is the most critical but total alkalinity and calcium hardness must also be watched closely. Low calcium hardness can lead to corrosion of equipment, while high calcium hardness can lead to scaling, cloudy water and staining. Water temperature should never exceed 40°C (104°F), and total dissolved solids should be kept below 1500 PPM.

Algicidal and sanitizing chemicals are either alkaline or acid. Sodium and calcium hypochlorites are alkaline. Chlorine gas and practically all other dry chlorine spa products are acid. On the market are a number of bromine sanitizers. Bromines are usually preferred since they don't emit a strong chlorine odor.

**SEE YOUR SPA WATER EXPERT FOR ADDITIONAL INFORMATION**

### **Damage due to improper chemistry will void warranty**

1. Check and adjust water conditions. You must maintain proper chemical balance to insure safe sanitary conditions and to prevent your spa from becoming a breeding place for bacteria. This is done by:
  - A. Test daily and maintain pH between 7.2 and 7.8. Adjust if necessary, above 7.8 use pH decrease, if below 7.2 use pH Increase. Improper pH can damage spa finish, equipment, cause eye irritation and chemical loss. Use dosage according to manufacturer's label.
  - B. Test alkalinity and maintain at 80 ppm to 140 ppm. Adjust if necessary, above 140 ppm use pH Decrease, if below 80 ppm use Total Alkalinity Control. Use dosage according to manufacturer's label.
  - C. Test daily and maintain proper sanitizer level. It's recommended to use bromine sanitizer and maintain bromine at 3.0 to 5.0 ppm. Typically, two or three bathers relaxing in an average spa with 39°C (103°F) temperature will consume all the bromine sanitizer in about twenty minutes. Therefore, prolonged or heavy use may require additional bromine to maintain safe sanitary conditions.
  - D. "Shock" (with a non-chlorine shock) once a week and after each water change. Do not use spa until the bromine residual has dropped to less than 5.0 ppm. NOTE: Improper pH will cause early corrosion to your pump. Corrosion is not handled under any warranty.

### **SPA MAINTENANCE SCHEDULE**

#### **DAILY**

Test and maintain pH: Ideal range 7.2 - 7.8b.

Test and maintain bromine: Ideal range 3.0 - 5.0 ppm.

#### **WEEKLY**

Test and maintain alkalinity 80 - 140 ppm. Shock with a non-chlorine shock.

Add Spa Clear.

#### **MAINTENANCE**

Add defoamer as needed.

Inspect filter cartridge every 2 weeks and clean when needed.

## Water Chemistry (Continued)

It is recommended that the spa be drained regularly depending on its size, location and the frequency of use.

1. Clean filter and cartridge periodically according to manufacturer's instructions.
2. Keep the spa covered when not in use to reduce the loss of heat and to keep out leaves, dirt, and other foreign materials from settling in the water.
3. Since the water capacity of your spa is far less than that of a swimming pool, the chemical reaction caused by the presence of one or more persons in the spa is more rapid and pronounced. For these reasons, it is important to frequently check the bromine level, the pH level and total alkalinity of water then add the prescribed chemicals as necessary to maintain the proper chemical balances.
4. If questions or doubts arise regarding quantities and timing of chemical applications to your spa, contact your spa dealer who can assist you in prescribing the correct program for your spa.
5. Store all chemicals in a cool dry place and in such a manner as to prevent contact by children and pets.
6. When adding chemicals to your spa water, add to the center of the spa with the pump operating. Never add chemicals to unheated water as this will affect chemical action.

---

---

---

---

---

---

---

---

---

---

---

---

## Replacing the LED Light

1. Disconnect electrical power to the spa.

2. Remove the cabinet access panel behind the light and the access panel to the spa control box.

3. Remove the control box cover, locate the light connector and unplug it from the receptacle.

4. Remove the cord strain relief by removing the screw.

5. Locate and turn the light holder counterclockwise and remove from the wall mounted clear lens.

6. Unplug the daisy chain connectors.

7. While grasping the light holder, turn the light clockwise a quarter turn to free it from the holder.

8. Pull the light cord all the way through the holder.

9. Route the replacement light's cord from the light lens, through the holder and to the control box. Install by reversing steps 7 through 1.

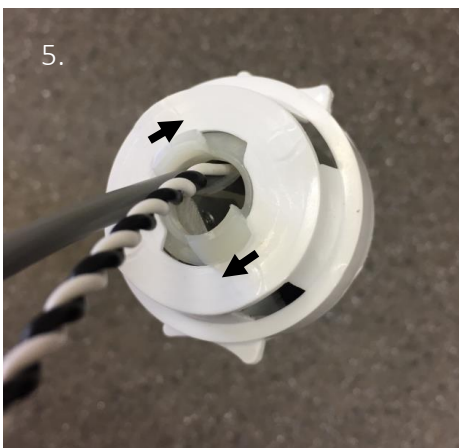
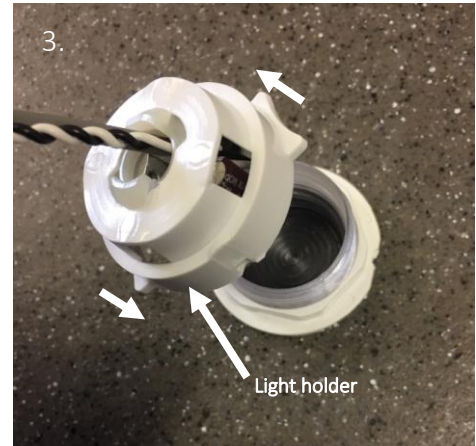
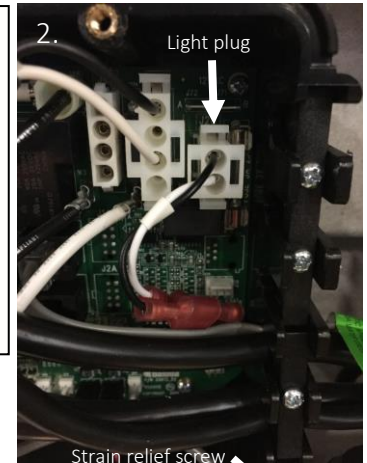
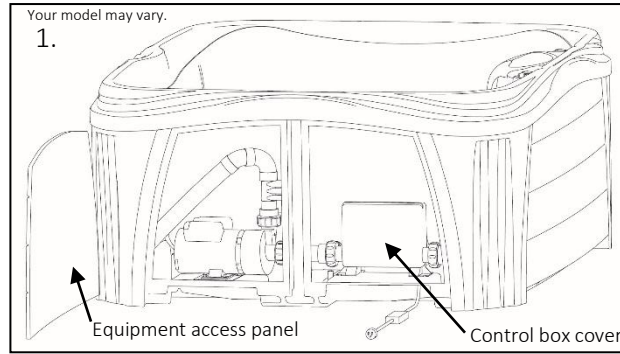

## Headrest Installation

Your headrests are designed to not be removed. However, if you need to reinstall the headrest on the spa, follow these steps.

1. Using a Phillips screwdriver, remove the cabinet panel(s) directly behind the headrest location.
2. Locate the two wing nuts and completely remove them turning counterclockwise (Fig 1).
3. Remove the two clear threaded fittings and insert their heads into the two outside holes in the back of the headrest (Fig 2). Using a hair blow dryer, heating the plastic around the holes first, may help this step, but is not required.
4. Insert the two clear threaded fittings into the corresponding holes in the spa shell (Fig 3).
5. Turn the wing nuts clockwise until they pull the headrests against the spa shell. Hand tight is sufficient.
6. Reinstall the panels.

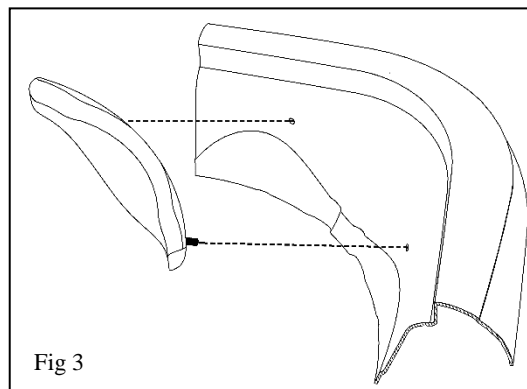
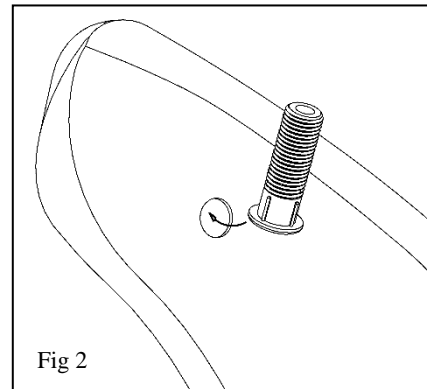
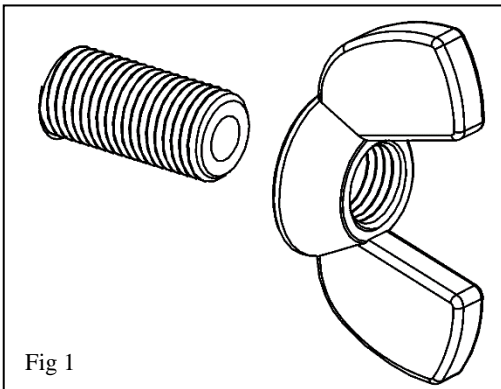

## Freeze Protection

### DO NOT ALLOW THE SPA TO FREEZE

Caution, any damage caused by improper winterizing will void the warranty. You may want consider contacting a spa professional for winterizing service.

If the spa is to be stored or transported in temperatures of 0°C (32°F) or lower, it is critical that the unit be fully winterized.

To winterize the spa, follow these steps:

1. The spa itself must be completely drained of water. See page 13 for draining instructions.
2. The drain valve must be in the open position and the cap removed.
3. Drain the pump by removing the pump wet-end drain plug (Fig 6.1). Leave this plug out until it is time to refill the spa. (Your pump model may vary.)



4. The filter cartridge must be removed, dried and stored. See page 23 for instructions for removing the filter cartridge.
5. The spa must be inverted (turned upside down) for at least five minutes to facilitate draining of the internal plumbing.

### CLEANING YOUR SPA

Do not use cleaners or compounds containing harsh abrasives. Also, avoid using heavy-duty rubbing or buffing compounds. Use a soft liquid cleaner.

### CARE OF WEATHER SHIELD COVER

Weather Shield is designed to be easy to maintain. It can be washed or brushed off and rinsed. Proper care and cleaning are important to the life of all fabrics.

FOR NORMAL CARE AND CLEANING. Add 2 ounces of mild soap such as Woolite or Dawn dishwashing liquid to 1 gallon of lukewarm water. Clean the fabric with a "soft bristle brush. Rinse thoroughly with cold water and air dry.

## Frequently Asked Questions

- Why does my spa not shut off?** Your spa is designed to run from the time you plug it in, until it reaches your desired water temperature. Once desired water temperature is reached then you can control the functions with the buttons on the top control. For example: On the initial startup the spa will run for up to 18 hours to reach 38°C (100°F). At that point the spa will shut off, and then the spa will maintain your desired temperature settings. Keep in mind that anytime power is disrupted to the spa, the spa will reset itself and run until it reaches the spa's default settings.
- Why does my spa turn on late at night?** The spa is designed to filter every 12 hours. The clock starts the second you plug it in. Recommend unplugging and plugging back in between 7 and 8. This means the spa will come on every 12 hours at the designated time and filter the amount of time you have it set for.
- Why is my spa not heating?** Spas heat at approximately 0.8°C (1.5°F) or more per hour. If your water temperature is 21°C (70°F) when you first fill your spa it will take up to about 20 hours to reach 38°C (100°F). Remember, it is imperative to keep your safety cover on and the air injection dials turned off while heating.
- How many gallons does my spa hold?**

First three characters on rating plate Model No	JS2, SS2, LS2, FS2	JC2, SC2, LC2, FS2	JC3, SC3, LC3, FC3	CS2,TQ2,TQ3	CS3	AC2	AC3
Liters	969	1155	1264	1189	1245	1340	1390
Gallons	256	305	334	314	329	354	367

- I see water on the floor. What does this mean?** The cover can accumulate condensation between the seams and run down the sides of the spa. You can verify that water is coming from the cover by squeezing the seam, or by repositioning the cover so that the seam is on a different side. This only occurs when the temperature and humidity are at certain levels.

## PURGING THE PUMP

Sometimes after a water change (draining and refilling the spa), or initial start-up of the spa, there is no water flowing from the jets. You may hear the pump operating or even see the shaft of the pump motor turning, but have no water flowing from the jets. In addition to no flow out of the jets, you may even see an error message dr, dY, HH, OH, HL, or LF. All of these error messages can be caused by a lack of water flow. When this happens there is probably an air-lock in the pump. This air-lock must be purged from the plumbing for the pump to operate normally.

To purge the pump, please follow these steps:

1. Ensure the spa is filled 15 to 20 cm (6 to 8 inches) below the top of the spa.
2. Remove the service panel to expose the water pump. Fig 1

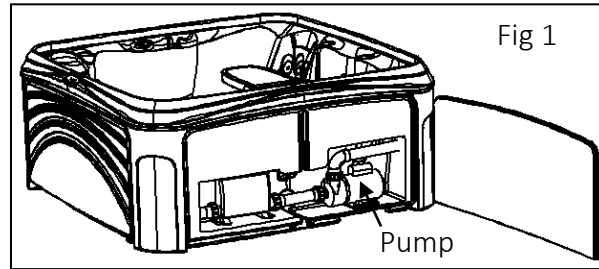

The pipes entering and leaving the pump are connected with large plastic unions. To purge the air from the pump, one of these unions will be slightly loosened.

3. Place a towel under the union to be loosened.
4. Using large pliers, slightly turn the union nut counterclockwise (Fig 2). This will produce a faint hissing sound of the trapped air escaping the pump. This will be followed by a small squirt of water which signals it is time to close the union by turning it back (clockwise). Do not over tighten the union. It is designed to be hand tight.

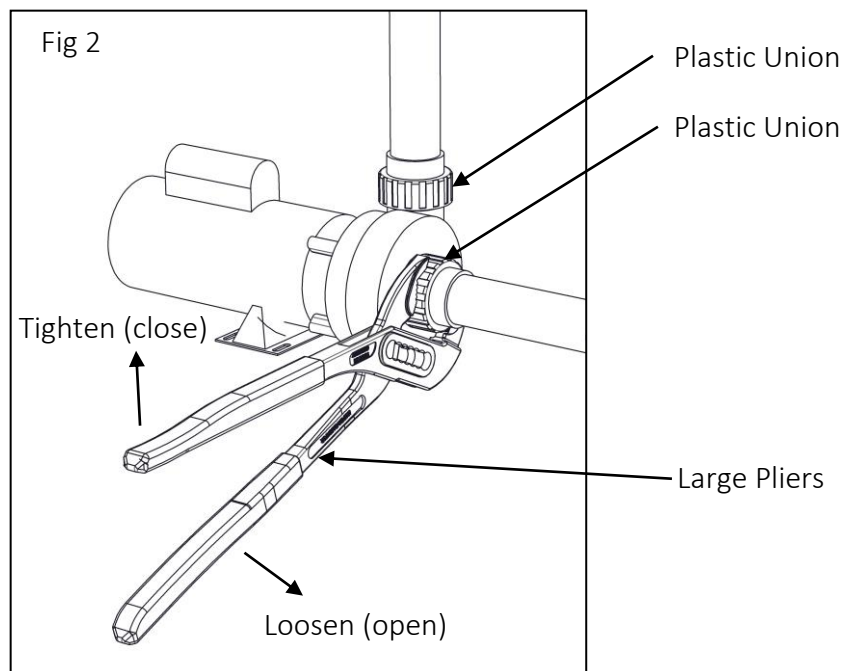

## Troubleshooting Guide

SITUATION	PROBABLE CAUSE	ACTION
NO HEAT OR HEAT TOO LOW	Operating while spa cover is open.	Ensure that spa cover is properly closed.
	Dirty filter	Replace or clean filter cartridge. Pg. 23
JETS WON'T COME ON	No power to spa control.	Check the RCD, circuit breaker and/or disconnect switch.
NO CONTROL DISPLAY OR FUNCTIONS	No power to spa control.	Check the RCD, circuit breaker and/or disconnect switch.
LOW WATER FLOW	Dirty filter.	Replace or clean filter cartridge. Pg. 23
	Low water level.	Make sure water level in spa is correct.
NO AIR BUBBLES IN JET	Air control valve in the closed position.	Open venturi dials. Pg. 24.
SPA IS LEAKING	Spa drain valve and cap partially open.	Ensure that drain valve and cap are fully closed. Pg. 12
NO SPA LIGHT	Burned out bulb.	Replace bulb. Pg. 27
SLOW WATER DRAIN	Drain valve not fully opened.	Ensure that the valve is fully open. Pg. 12
	Dirty filter.	Remove filter cartridge and clean. Pg.23
	Kinked garden hose	Ensure drain hose is not kinked and is in a downhill direction.
NO WATER FLOW FROM JETS	Air lock in pump	Purge the pump. Pg. 31



**Venturi dials**

Mounted on the lip of the spa or at the equipment shroud, to induce air to the jets.

**BYPASS CHECK VALVE**

Prevents water flow stoppage due to dirty filter.

**CONTROL BOX**

Basically, the brain of the spa. Power is distributed to all functions of the spa, pumps, lights, heat, etc.

**DRAIN VALVE**

Used in the draining of the spa, looks like an outdoor faucet and fits a standard garden hose.

**FILTER**

The filter cleans the spa and removes particles and debris and protects the equipment from foreign substances.

**FOOTWELL**

The bottom of a spa where you place your feet.

**RCD**

RCD is an abbreviation for a residual-current device. This device quickly disconnects current to prevent serious harm from an electric shock.

**HEATER**

The thermostatically controlled heater raises the temperature of the water to the desired degree. This is located under the control box in the equipment area.

**JETS**

The fittings on your spa that direct the flow of water for massaging action.

**pH**

Stands for "Potential for Hydrogen" This is the term used to describe the acid (low pH) or alkalinity (high pH) condition of the water. The ideal pH for spa water is 7.5.

**SKIMMER**

The skimmer removes surface debris to the filter. The water level in the spa should be kept at the proper range for optimum skimmer operation.

**TOP CONTROL PANEL**

Mounted on the lip of the spa. The digital panel that controls the spas functions.

## Your Spa's Ozonate. (If equipped)

If you ordered your spa with the optional ozonator installed, you can confirm this by viewing the spa's rating plate. The rating plate is located near the floor and equipment access door. As shown below, look in the option box to confirm the ozonator has been installed. The word "OZONE" will be seen.

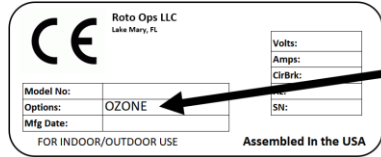

Further to verifying the ozone option is installed on your spa. If you look in the equipment compartment you will see a small black or blue box, about 6.6cm x 8.4cm x 3.3cm (2.6 inches by 3.3 inches x 1.3 inches). It will be either strapped to the plumbing or mounted on a wall, as shown below.

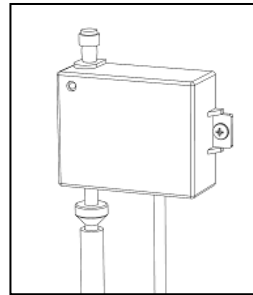
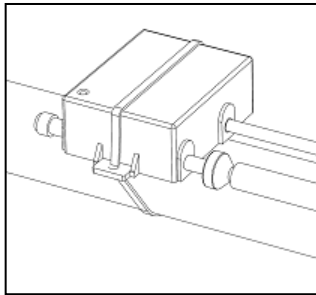

Ozone is an oxidizer used to sanitize water and air. Ozone is created naturally in the environment during thunderstorms. The electric charge created by lightning converts the oxygen in the air into ozone. Your ozonator creates ozone using the same principle. It utilizes a very high electric charge to convert oxygen into ozone. This ozone is then injected into the spa's water stream and eventually through two of the spa's jets. These jets will always produce air bubbles (however fine they may be) while the pump is operating and are not controlled by the air injector venturi dials.

The oxygen in the air is normally O<sub>2</sub>. That is a molecule consisting of two atoms of oxygen. When exposed to a high electrical charge, a 3<sup>rd</sup> oxygen atom is added to some of the O<sub>2</sub>, forming O<sub>3</sub> (ozone). The weak bond holding the third oxygen atom causes the molecule to be unstable. An oxidation reaction occurs upon any collision between an ozone molecule and a molecule of a substance that can be oxidized, i.e. bacteria, fungi, mould, yeast, viruses, and forms of metals. The weak bond 3<sup>rd</sup> oxygen atom splits off to these substances, leaving oxygen (O<sub>2</sub>) as a by-product. During this oxidation reaction, organic molecules are changed and dissolved metals are made no longer soluble.

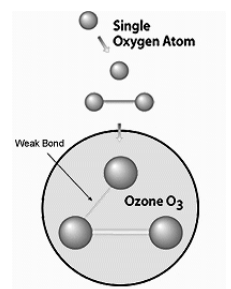

Although ozone is more effective than chlorine, chloramines and chlorine dioxide for inactivation of viruses, Cryptosporidium and Giardia; it dissipates very quickly. For this reason, ozone can only be used as a secondary sanitizer, to enhance the primary sanitizer used to keep your spa safe. You must use a primary source of sanitizer which is always present in the spa water. Please see the Water Chemistry section of the spa owner's manual for further information about sanitizers.